

Ona Desk



Simple modular design, flexible combinations



Jorge Pensi

Jorge Pensi , a spanish famous designer who was born in the Capital City of Argentina in 1946.

In 1977, he partnered up with Alberto Lievone and they had worked together until 1984. Then Pensi established his own design studio in Barcelona and started working on designs of furniture, lamps and buildings.

Jorge Pensi has been awarded with many honors, including the Spanish National Design Prize which he won in 1997.

Jorge Pensi also works with Kusch+Co, a high-end German office furniture manufacturer. Together they have created a series of well received classic products, such as Hola, Ona desk, Ona work , Ona Executive and Ronda.

8400 ONA DESK

Design: Jorge Pensi



With all-covered specifications, Kusch_co Ona Desk is capable of fitting into a wide range of spaces, such as meeting rooms, training rooms, dining and reception areas. It is extraordinarily compatible with customers' needs and highly flexible to realize them.

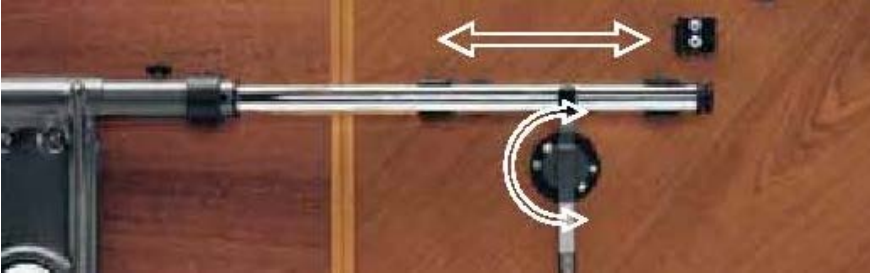





- Fine materials selected (aluminum alloy polished table legs)
- (all aluminum alloy polishing feet)
- Modular structure to ensure free, stable combinations, multi-angle connection and convenient recombination
- Flexible, powerful routing
- Legs of different depth are matched with corresponding desk frame to fit different shapes and sizes of table. With a reasonable connection structure, its stability can be better than other similar metal structures



Table legs

8400 big table legs

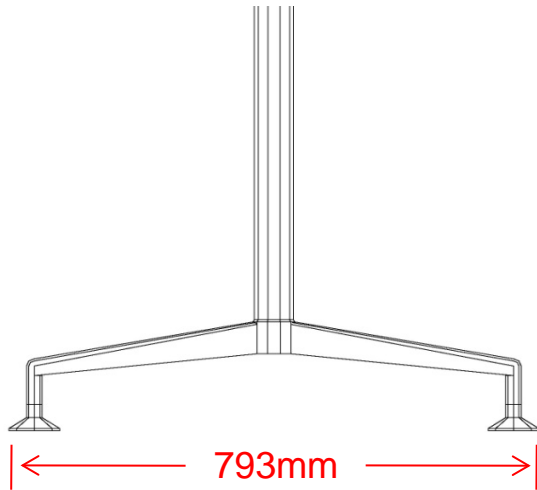

- Can be used with stand-alone or combined frame
- Minimum depth of stand-alone frame 900mm Maximum depth 1000mm
- Minimum depth of combined frame 900mm Maximum depth 1500mm

8400 small table legs

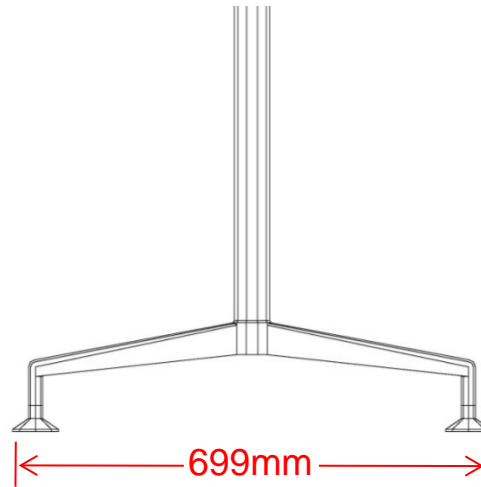

- Can be used with stand-alone or combined frame
- Minimum depth of stand-alone frame 800mm Maximum depth 1000mm
- Minimum depth of combined frame 800mm Maximum depth 1200mm

Wood legs

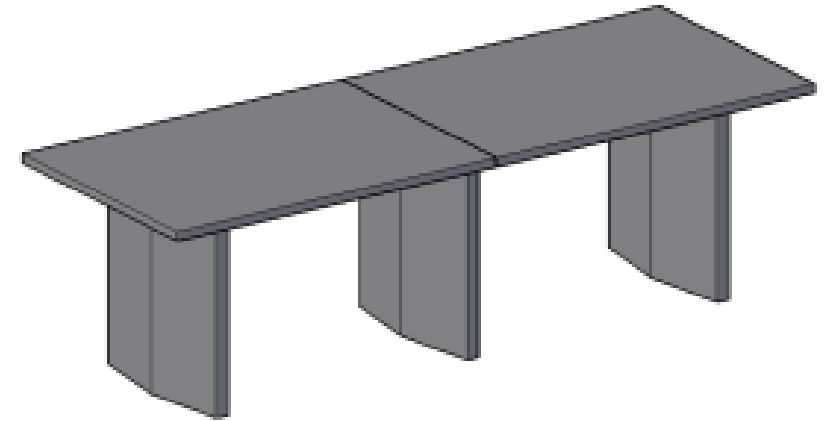

- Fit with all depths
- Enhanced sturdiness

Table top shapes & edge shapes

Oval

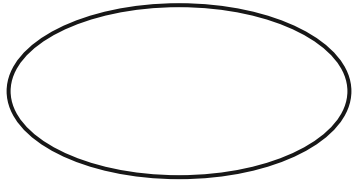

Rectangle

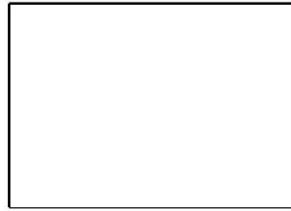

Horse belly

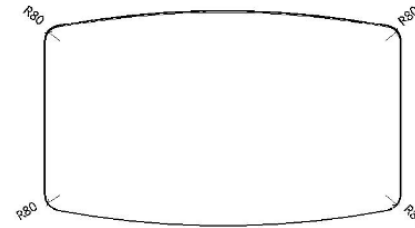
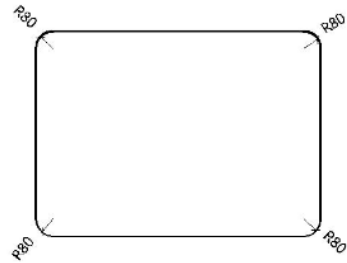
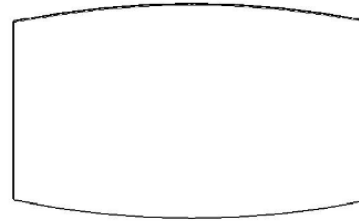

MFC 30mm
PVC straight edge

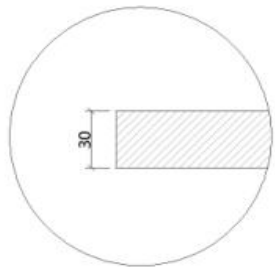

MFC 30mm
Wood straight edge

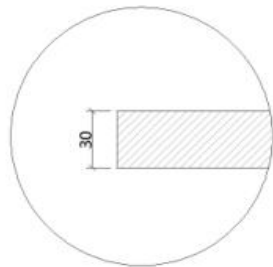

HPL 32mm
PVC straight edge

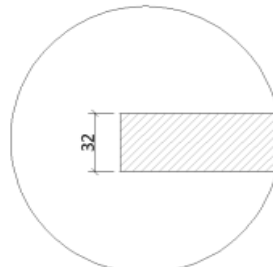

Wood veneer 35mm
straight edge

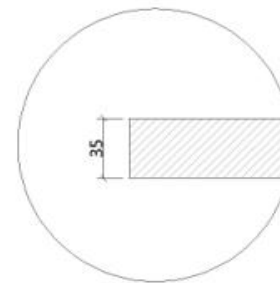

Wood veneer 35mm
Inward bevel edge

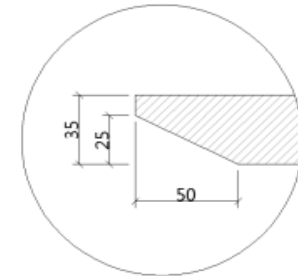

Combined forms

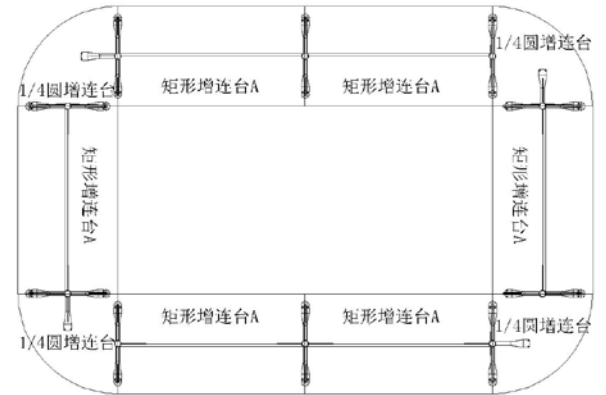
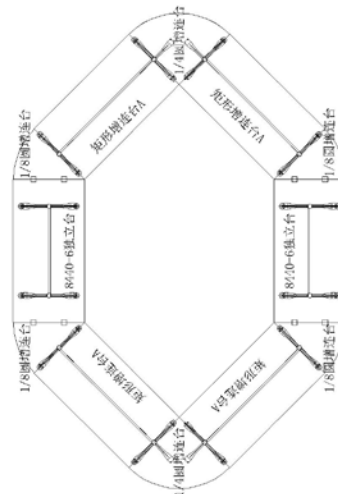
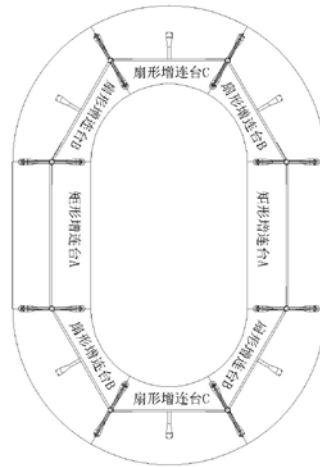
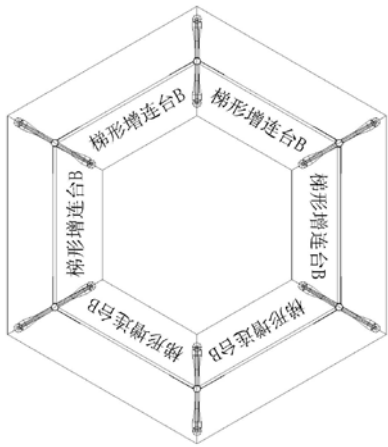
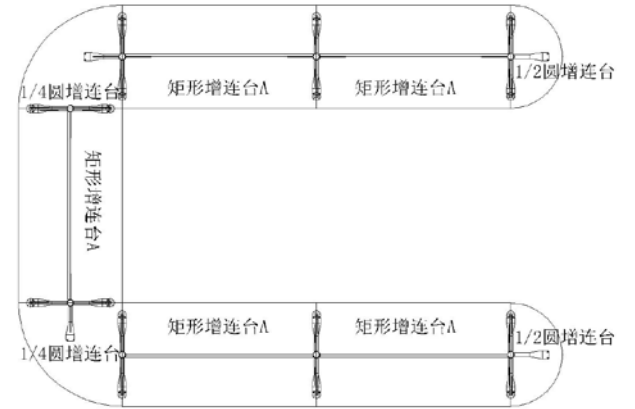
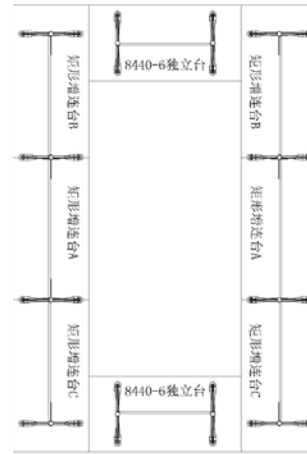
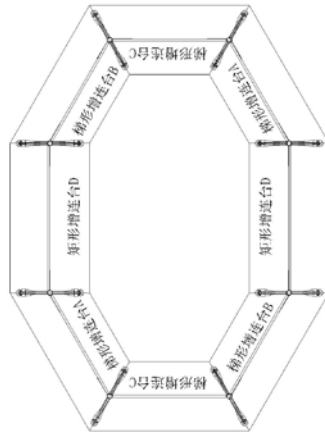

SHANGHAI
BEIJING
SHENZHEN
WUHAN

www.matsu.cn 

Inspiring Office Lifestyle

创造激发灵感的办公生活方式

玛祖铭立集团

成立于 1996 年，一直致力于为高端客户提供个性化、极致设计的办公空间整体解决方案，旗下产品涵盖办公空间家具、公共空间家具、LED 照明系统、办公室隔断系统、地毯，以期为客户创造激发灵感的办公生活方式。

玛祖铭立自 2001 年与德国著名家具企业 Kusch+co 建立合作至今，已与八个德国高端品牌结成密切的战略合作伙伴，并在中国建立生产基地，精良严谨的德国工艺与作业风格贯穿整个制造体系与工作环节。

MATSU GROUP

上海市徐汇区肇嘉浜路 686 号

No. 686 Zhaoliabang Road, Xuhui District, Shanghai, P. R. China, P.C.: 200030

T +86 21 3338 6166

Customer Service Hotline 400 630 9229

MATSU 玛祖铭立
GROUP

